

Box End Wrenches

F430M



45° Offset Box End Wrench METRIC Chrome 12Pt

Item	Size	LBS	\$
F430M0809	8 x 9MM	0.12	11.51
F430M0810	8 x 10MM	0.12	11.51
F430M1012	10 x 12MM	0.13	11.51
F430M1113	11 x 13MM	0.14	11.80
F430M1214	12 x 14MM	0.22	12.77
F430M1417	14 x 17MM	0.33	12.83
F430M1719	17 x 19MM	0.49	16.47
F430M1921	19 x 21MM	0.75	20.03
F430M2224	22 x 24MM	0.97	22.30
F430M2326	23 x 26MM	1.03	25.10
F430M2427	24 x 27MM	1.07	26.30

F430S



45° Offset Box End Wrench SAE Chrome 12Pt

Item	Size	LBS	\$
F430S1214	3/8" x 7/16"	0.13	15.91
F430S1618	1/2" x 9/16"	0.22	17.84
F430S2022	5/8" x 11/16"	0.33	19.17
F430S2428	3/4" x 7/8"	0.75	26.91
F430S3032	15/16" x 1"	1.01	35.39

F330S



75° Offset Box End Wrench SAE Chrome 12Pt

Item	Size	LBS	\$
F330S0810	1/4" x 5/16"	0.09	11.91
F330S1012	5/16" x 3/8"	0.14	12.80
F330S1214	3/8" x 7/16"	0.19	13.93
F330S1416	7/16" x 1/2"	0.29	16.87
F330S1618	1/2" x 9/16"	0.29	16.87
F330S1820	9/16" x 5/8"	0.33	18.50
F330S2022	5/8" x 11/16"	0.42	18.50
F330S2224	11/16" x 3/4"	0.53	21.15
F330S2428	3/4" x 7/8"	0.73	24.49
F330S2628	13/16" x 7/8"	0.73	28.94
F330S3032	15/16" x 1"	0.96	32.83
F330S3436	1-1/16" x 1-1/8"	1.07	37.79



1960



45° Offset Box End Wrenches Satin 12Pt

Item	Size	LBS	\$
19601011	10 x 11	0.13	7.24
19601214	12 x 14	0.22	8.77
19601415	14 x 15	0.33	10.81
19601719	17x19	0.49	12.39
19603032	30x32	1.43	34.73



1970



75° Offset Box End Wrench METRIC Satin 12Pt

Item	Size	LBS	\$
19700607	6 x 7	0.09	6.92
19700809	8 x 9	0.14	7.70
19700810	8 x 10	0.14	7.70
19701011	10 x 11	0.19	8.90
19701012	10 x 12	0.19	9.07
19701113	11 x 13	0.29	9.48
19701213	12 x 13	0.29	9.48
19701214	12 x 14	0.29	9.48
19701314	13 x 14	0.29	10.20
19701415	14 x 15	0.33	11.51
19701417	14 x 17	0.42	12.50
19701617	16 x 17	0.42	12.50
19701719	17 x 19	0.53	14.06
19701819	18 x 19	0.53	14.06
19701921	19 x 21	0.73	15.20
19702022	20 x 22	0.73	15.20
19702123	21 x 23	0.80	17.95
19702224	22 x 24	0.80	17.95
19702326	23 x 26	0.96	20.48
19702426	24 x 26	0.96	20.48
19702427	24 x 27	0.96	20.48
19702528	25 x 28	1.07	23.68
19703032	30 x 32	1.32	27.81

Many of these items are available with Hang Tags for 6% additional charge



Special Purpose Wrenches

3203

Strap Wrench 9-3/16"L



Item	Size	LBS	\$
3203	2~5-1/2	0.53	33.19
3203A0	2~10-1/4	0.66	41.90

3204

Chain Wrench 8-7/8"L



Item	Size	LBS	\$
3204	2~5-1/2	0.79	26.32

6531

Pipe Wrench



Item	Size	LBS	\$
6531-10	1-3/16"	1.32	26.73
6531-12	1-9/16"	1.72	32.22
6531-14	2"	2.32	42.54
6531-18	2-3/8"	3.79	55.90
6531-24	2-15/16"	6.95	80.80
6531-36	4-5/32"	13.85	188.54
6531-48	4-13/32"	21.50	279.37

Adjustable Wrenches

3611P

Adjustable Wrench METRIC Black



Item	Size	LBS	\$
3611-06P	6"	0.28	19.53
3611-08P	8"	0.55	20.95
3611-10P	10"	0.95	26.17
3611-12P	12"	1.50	39.18

3621RQ

Adjustable Wrench SAE & METRIC Satin



Item	Size	LBS	\$
3621-06RQ	6"	0.28	19.96
3621-08RQ	8"	0.55	24.38
3621-10RQ	10"	0.95	29.09
3621-12RQ	12"	1.50	42.24
3621-15RQ	15"	2.64	75.08

3611-15HP

Adjustable Wrench METRIC Black



Item	Size	LBS	\$
3611-15HP	15"	2.64	62.95

3611-15HR

Adjustable Wrench METRIC



Item	Size	LBS	\$
3611-15HR	15"	2.64	75.08

Ratchet Adjustable Wrench

3631-10R \$64.24

Ratchet Adjustable Wrench

1.31LBS



Many of these items are available with Hang Tags for 6% additional charge

Combination & Open End Wrenches

G2110S



180° Flexible Head Speed Wrench SAE Chrome 12Pt

Item	Size	LBS	\$
G2110S10	5/16"	0.09	22.08
G2110S12	3/8"	0.13	22.65
G2110S14	7/16"	0.13	24.35
G2110S16	1/2"	0.22	24.92
G2110S18	9/16"	0.22	26.05
G2110S20	5/8"	0.35	28.63
G2110S22	11/16"	0.40	28.88
G2110S24	3/4"	0.48	31.93
G2110S28	7/8"	0.80	56.65

G2110M



180° Flexible Head Speed Wrench METRIC Chrome 12Pt

Item	Size	LBS	\$
G2110M08	8MM	0.09	21.52
G2110M09	9MM	0.09	22.15
G2110M10	10MM	0.13	22.65
G2110M11	11MM	0.13	24.35
G2110M12	12MM	0.18	24.92
G2110M13	13MM	0.22	26.62
G2110M14	14MM	0.22	27.30
G2110M15	15MM	0.26	28.88
G2110M16	16MM	0.35	30.01
G2110M17	17MM	0.40	31.93
G2110M18	18MM	0.44	32.28
G2110M19	19MM	0.48	32.28

G2140S



Box End Speed Wrench SAE Chrome 12Pt

Item	Size	LBS	\$
G2140S0810	1/4" x 5/16"	0.08	29.36
G2140S1012	5/16" x 3/8"	0.10	30.13
G2140S1214	3/8" x 7/16"	0.14	31.45
G2140S1416	7/16" x 1/2"	0.22	34.04
G2140S1820	9/16" x 5/8"	0.26	36.65
G2140S2224	11/16" x 3/4"	0.46	42.57





G2140M







Box End Speed Wrench METRIC Chrome 12Pt

Item	Size	LBS	\$
G2140M0809	8 x 9MM	0.10	30.13
G2140M1011	10 x 11MM	0.14	31.45
G2140M1213	12 x 13MM	0.22	34.04
G2140M1415	14 x 15MM	0.26	36.65
G2140M1618	16 x 18MM	0.42	40.99
G2140M1719	17 x 19MM	0.46	42.57

Bit & Socket Adapters For Speed Wrenches

Item	Size	Function	\$
G21002HS12		1/4" Bit	10.04
G21002HM10		1/4" Bit	10.04
G21002RS12		1/4" Drive	12.75
G21002RM10		1/4" Drive	12.75

Item	Size	Function	\$
G21003RS16		3/8" Drive	13.96
G21003RM13		3/8" Drive	13.96
G21004RS24		1/2" Drive	15.57
G21004RM19		1/2" Drive	15.57

Many of these items are available with Hang Tags for 6% additional charge

Speed Wrenches



G2120S

Combination Speed Wrench SAE Chrome 12Pt

Item	Size	LBS	\$
G2120S10	5/16"	0.06	18.53
G2120S12	3/8"	0.09	19.15
G2120S14	7/16"	0.13	21.00
G2120S16	1/2"	0.18	21.52
G2120S18	9/16"	0.22	21.52
G2120S20	5/8"	0.30	24.74
G2120S22	11/16"	0.36	26.05
G2120S24	3/4"	0.50	27.31
G2120S26	13/16"	0.70	36.05
G2120S28	7/8"	0.75	37.07
G2120S30	15/16"	1.05	42.75



G2130S

Reversible Combination Speed Wrench SAE Chrome 12Pt

Item	Size	LBS	\$
G2130S10	5/16"	0.04	20.14
G2130S12	3/8"	0.09	21.17
G2130S14	7/16"	0.13	22.81
G2130S16	1/2"	0.21	24.00
G2130S18	9/16"	0.24	25.24
G2130S20	5/8"	0.35	28.48
G2130S22	11/16"	0.39	29.75
G2130S24	3/4"	0.48	32.19
G2130S26	13/16"	0.70	45.37
G2130S28	7/8"	0.70	46.35
G2130S30	15/16"	1.02	56.64

G2120M

Combination Speed Wrench METRIC SAE Chrome 12Pt

Item	Size	LBS	\$
G2120M08	8MM	0.06	16.42
G2120M09	9MM	0.08	16.98
G2120M10	10MM	0.09	17.55
G2120M11	11MM	0.13	18.08
G2120M12	12MM	0.17	19.82
G2120M13	13MM	0.18	21.52
G2120M14	14MM	0.22	22.65
G2120M15	15MM	0.25	23.78
G2120M16	16MM	0.30	24.74
G2120M17	17MM	0.36	24.92
G2120M18	18MM	0.43	26.05
G2120M19	19MM	0.50	27.31
G2120M21	21MM	0.70	37.07
G2120M22	22MM	0.75	42.75
G2120M24	24MM	1.05	46.35

G2130M

Reversible Combination Speed Wrench METRIC Chrome 12Pt

Item	Size	LBS	\$
G2130M08	8MM	0.04	19.06
G2130M09	9MM	0.06	19.57
G2130M10	10MM	0.09	20.60
G2130M11	11MM	0.13	21.51
G2130M12	12MM	0.17	22.81
G2130M13	13MM	0.21	23.23
G2130M14	14MM	0.24	24.87
G2130M15	15MM	0.26	25.90
G2130M16	16MM	0.35	28.48
G2130M17	17MM	0.39	29.75
G2130M18	18MM	0.45	30.89
G2130M19	19MM	0.48	31.98
G2130M21	21MM	0.70	45.37
G2130M22	22MM	0.70	46.35
G2130M24	24MM	1.02	56.64

Many of these items are available with Hang Tags for 6% additional charge

Torque Tools



IT'S GOOD TO BE THE KING.

SAE & Metric

Knurl & Rubber Handle

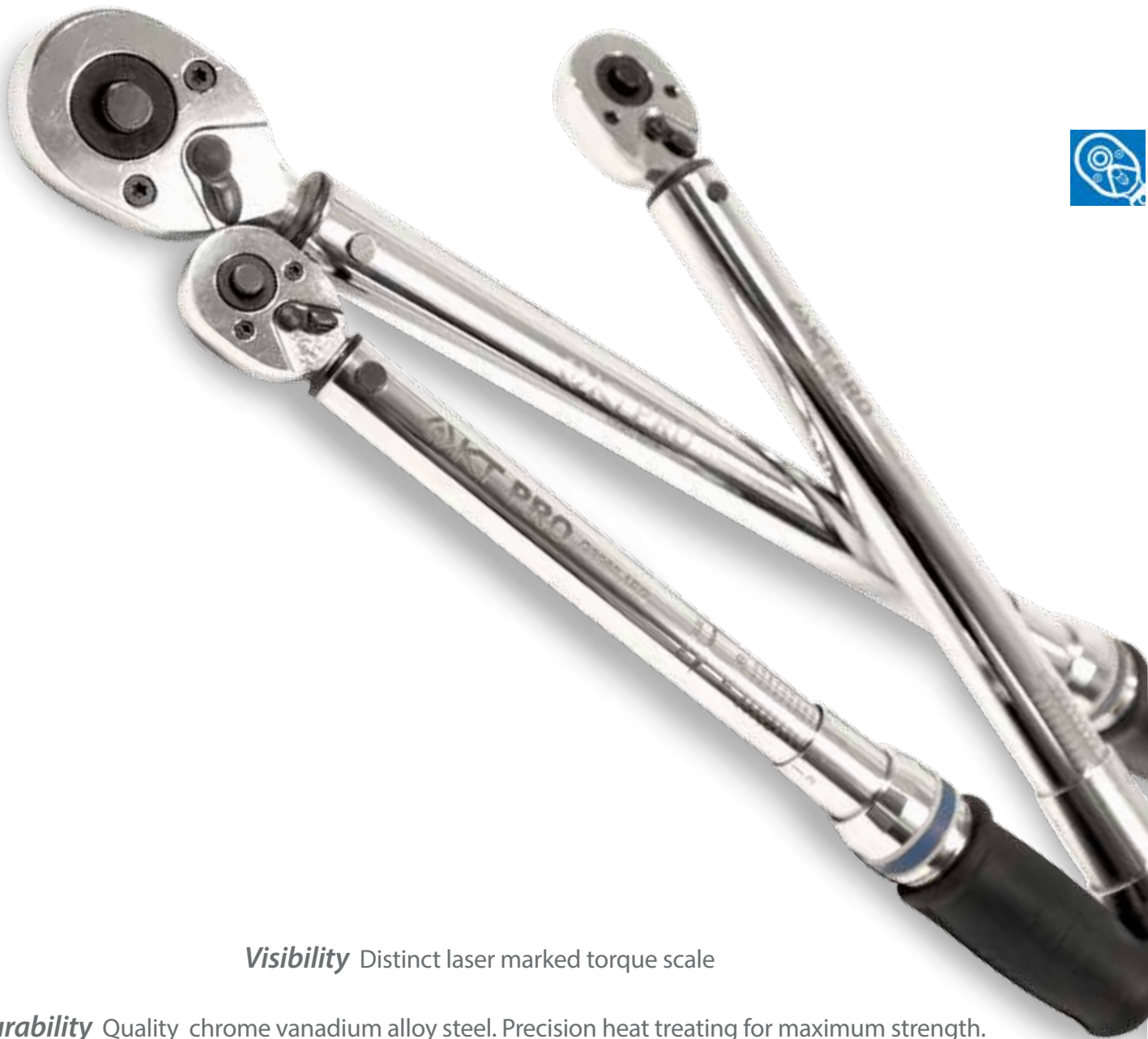

Visibility Distinct laser marked torque scale

Durability Quality chrome vanadium alloy steel. Precision heat treating for maximum strength.

Precision According to ASME B107.14M-2004 Tolerance of Torque $\pm 3\%$

Manufactured to ANSI & DIN industrial standards.



Torque Tools



Quick release

Distinct laser marked torque scale

Comfortable rubber handle

Industrial knurl handle





Convenient molded Box



G3262

Adjustable Torque Wrench -- Single Scale SAE (EG) or METRIC (DG)

No.	Torque Range				Total Length			\$
	Square Drive	Major Scale			Inch	Lbs.		
	Inch	Nm	ft-lb	Inc-in lb.	Incr			
G3262-1DG1*	1/4"	40~20	-	-	0.1	12-3/4"	1.41	191.97
G3262-1EG1*	1/4"	-	-	30~200	1	12-3/4"	1.41	191.97
G3362-2DG1*	3/8"	20~100	-	-	0.5	17-1/8"	2.86	205.17
G3362-2EG1*	3/8"	-	10~80	-	0.5	17-1/8"	2.86	205.17
G3462-1DG1*	1/2"	40~200	-	-	1	20-1/2"	3.50	216.14
G3462-1EG1*	1/2"	-	20~150	-	1	20-1/2"	3.50	216.14
G3462-2DG1*	1/2"	60~340	-	-	2	24-1/8"	3.78	230.09
G3462-2EG1*	1/2"	-	30~250	-	1	24-1/8"	3.78	230.09
G3462-3EG1	1/2"	-	10~80	-	0.5	17-1/8"	3.78	216.14
G3662-2DG	3/4"	150~800	-	-	5	48-9/16"	12.10	879.86
G3662-2EG	3/4"	-	100~600	-	5	48-9/16"	12.10	879.86
G3862-1DG	1"	200~1000	-	-	5	48-9/16"	12.10	926.43
G3862-1EG	1"	-	150~750	-	5	48-9/16"	12.10	926.43
 G3462-1EF1*	1/2"	-	20~150	-	1	20-1/2"	3.50	216.14
 G3462-2EF1*	1/2"	-	30~250	-	1	24-1/8"	3.78	230.09
 G3462-3EF1	1/2"	-	10~80	-	0.5	17-1/8"	3.78	216.14

* - Quick Release G - Rubber Handle F - Knurl Handle

Torque Tools



SAE scale

METRIC scale



Repair Kit

Adjustable Torque Wrench – Dual Scale – SAE Scale (Front) METRIC Scale (Back)

No.	Square Drive Inch	Torque Range				Total Length		\$
		Major Scale Nm	ft-lb	Inc -in lb.	Incr	Inch	Lbs.	
G3362-2CG1*	3/8"	20-100	10~80	-	0.5	17-1/8"	3.60	222.67
G3462-1CG1*	1/2"	40-200	20-150	-	1	20-1/2"	4.38	233.64
G3462-2CG1*	1/2"	60-340	30-250	-	2	24-1/8"	4.91	247.59
G3662-2CG	3/4"	150-800	100-600	-	5	48-9/16"	15.16	897.36
34262-1DK	1/4"	1/4 Dr. Torque WRH Renewal Kit				-	0.08	15.25
34362-2DK	3/8"	3/8 Dr. Torque WRH Renewal Kit #2				-	0.19	17.89
34462-1DK	1/2"	1/2 Dr. Torque WRH Renewal Kit				-	0.34	22.22
34662-1DK	3/4"	3/4 Dr. Torque WRH Renewal Kit #1				-	1.04	53.80
34862-1DK	1"	1" Dr. Torque WRH Renewal Kit				-	1.21	57.29
34862-2DK	1"	1" Dr. Torque WRH Renewal Kit 3XG Series				-	1.50	160.40



* – Quick Release G – Rubber Handle F – Knurl Handle

Torque Screwdrivers & Torque Multiplier



Aluminum alloy



Tolerance of torque within $\pm 5\%$ quality meets DIN ISO 6789 & ASME B107.14M-2004

34111

1/4" Dr. Torque Screwdriver

No.	Size	Torque Range		Total Length		
		Inc-in lb.	Incr	Inch	LBS	\$
34111-2EG	1/4"	10-50 in-lb	0.5in-lb	9-4/3"	1.05	272.00

Reaction bar supplied in two styles for maximum versatility.



Convenient, Portable carrying case.

34688

3/4" 3Pc. Torque Multiplier

Item No.	Input Square	Output Square	Nm/lbf.ft	LBS	\$
34688-05A	3/4"	1"	2700/2000	8.80	852.20

4-1 MUTIPLIER

Interchangeable Torque Wrench Set

345203E11SR

\$620.00

11Pc. Interchangeable Torque Wrench Set SAE



93.20 LBS



Interchangeable Torque Wrench

Item	Size	LBS	\$
34522-3EG	30-250	3.50	237.00



Open End Insert Tools

Item	Size	LBS	\$
34501220S	5/8"	0.28	28.98
34501222S	11/16"	0.29	28.98
34501224S	3/4"	0.30	28.98
34501226S	13/16"	0.34	30.86
34501228S	7/8"	0.35	30.86
34501230S	15/16"	0.36	30.86
34501232S	1"	0.51	40.54
34501236S	1-1/8"	0.53	40.54
34501240S	1-1/4"	0.55	40.54

345203E11R Content:

Item	Size	LBS
34501220S	5/8"	0.28
34501222S	11/16"	0.29
34501224S	3/4"	0.30
34501226S	13/16"	0.34
34501228S	7/8"	0.35
34501230S	15/16"	0.36
34501232S	1"	0.51
34501236S	1-1/8"	0.53
34501240S	1-1/4"	0.55
34522-3EG	30-250	3.50
34503204R	14x18MM	0.56



Ratchet insert Tool

Item	Size	LBS	\$
34503204R	14x18MM	0.56	81.20



Screwdrivers, Hex Keys & Bits

SAE & METRIC • ROUND SHANK & GRIP MATERIAL
PHILLIPS, SLOTTED, Torx, POZIDRIV



Standard Screwdrivers & Sets
Heavy Duty Screwdrivers & Sets
Insulated Screwdrivers & Sets
Precision Screwdrivers & Sets
Nut Spinners & Sets
Reversible Screwdrivers & Sets
Bits & Sets
Power Bits
Hex Keys & Sets
Star L Wrenches & Sets

Precision

Manufactured to ANSI & DIN industrial standards

Durability

Quality material chrome vanadium alloy steel. Precision heat treating for maximum strength.

Strength

Molded unitary construction.

Ergonomic

Oversized handle for maximum comfort and noslip grip surface.

Standard Screwdrivers



M121

Screwdriver Phillips Head Round Shank

Item	Size	LBS	\$
M1210023	#0, 1/8 x 2-3/8"	0.08	4.29
M1210104	#1, 3/16" x 4"	0.09	5.15
M1210132	#1, 3/16 x 3-1/8"	0.11	5.24
M1210204	#2, 1/4 x 4"	0.08	6.49
M1210206	#2, 1/4 x 6"	0.16	6.71
M1210214	#2, 1/4 x 1-1/2"	0.21	4.76
M1210306	#3, 5/16 x 6"	0.29	8.98
M1210408	#4, 5/16 x 8"	0.33	11.35



M127

Screwdriver Torx Head Round Shank

Item	Size	LBS	\$
M1270803	T8, 1/8 x 3"	0.11	5.46
M1270903	T9, 1/8 x 3"	0.11	5.46
M1271003	T10, 1/8 x 3"	0.11	5.46
M1271503	T15, 5/32 x 3"	0.12	5.83
M1272004	T20, 3/16 x 4"	0.12	5.83
M1272504	T25, 3/16 x 4"	0.18	6.62
M1272704	T27, 1/4 x 4"	0.18	6.62
M1273005	T30, 1/4 x 5"	0.20	6.72
M1274006	T40, 5/16 x 6"	0.31	7.19



M122

Screwdriver Slotted Head Round Shank

Item	Size	LBS	\$
M1220303	1/8 x 3"	0.08	4.57
M1220304	1/8 x 4"	0.09	4.95
M1220306	1/8 x 6"	0.11	5.51
M1220308	1/8 x 8"	0.13	6.09
M1220404	5/32 x 4"	0.09	5.27
M1220503	3/16 x 3"	0.09	5.65
M1220504	3/16 x 4"	0.10	5.47
M1220505	3/16 x 5"	0.14	5.59
M1220506	3/16 x 6"	0.15	5.93
M1220508	3/16 x 8"	0.16	6.93
M1220806	5/16 x 6"	0.29	8.19
M1220807	5/16 x 7"	0.31	8.43
M1220808	5/16 x 8"	0.33	8.75
M1225503	7/32 x 3"	0.11	5.26
M1225504	7/32 x 4"	0.13	5.39
M1225505	7/32 x 5"	0.15	5.39
M1225506	7/32 x 6"	0.18	5.70
M1226504	1/4 x 4"	0.13	6.12
M1226506	1/4 x 6"	0.19	6.62
M1226514	1/4 x 1-1/2"	0.10	4.64
M1229508	3/8 x 8"	0.35	10.49
M1229510	3/8 x 10"	0.37	11.34



M128

Screwdriver Pozidrive Head Round Shank

Item	Size	LBS	\$
M1280023	#0, 1/8 x 2-3/8"	0.08	5.39
M1280104	#1, 3/16 x 4"	0.09	6.03
M1280132	#1, 3/16 x 3-1/8"	0.11	5.89
M1280204	#2, 1/4 x 4"	0.16	6.72
M1280306	#3, 5/16 x 6"	0.29	9.06

Many of these items are available with Hang Tags for 6% additional charge

Standard & Heavy Duty Screwdrivers

6Pc. PH+SLT Head Screwdriver Set W/ Color Box



31216MR
\$39.92

Phillips Head
No.1x3/16"x3-1/8"L,
No.2x1/4"x4"L
Slotted Head
3/16"x3"L, 3/16"x4"L,
1/4"x4"L, 1/4"x6"L
1.23 LBS



1461

Heavy Duty Screwdriver Phillips Head Hex Shank



Item	Size	LBS	\$
14610103	#1, 7/32"x3"	0.24	12.58
14610204	#2, 1/4"x4"	0.28	13.63
14610306	#3, 5/16"x6"	0.45	17.33



5Pc. PH+SLT Head Screwdriver Set W/ Color Box



30115MR
\$35.11

Phillips Head
No.1x3/16"x3-1/8"L,
No.2x1/4"x4"L
Slotted Head
5/32"x4"L, 7/32"x5"L,
1/4"x6"L
1.20 LBS



1462

Heavy Duty Screwdriver Slotted Head Hex Shank



Item	Size	LBS	\$
14625504	7/32" X 4"	0.25	13.00
14626504	1/4" X 4"	0.30	14.03
14626506	1/4" X 6"	0.34	14.30
14620806	5/16" X 6"	0.48	18.23
14620807	5/16" X 7"	0.48	18.23

9Pc. Torx Tip Screwdriver Set W/Color Box



30309PR
\$73.42

Torx Head
T8x18"x3"L, T9x1/8"x3"L,
T10x18"x3"L, T15x5/32"x3"L,
T20x3/16"x4"L, T25x3/16"x4"L,
T27x1/4"x4"L,
T30x1/4"x5"L, T40x5/16"x6"L
2.00 LBS

6Pc. Heavy Duty PH+SLT Screwdriver Set W/Color Box



30206MR
\$62.02

Phillips Head
No.1x3"L, No.2x4"L,
No.3x6"L
Slotted Head
7/32"x4"L, 1/4"x6"L,
5/16"x7"L
2.64 LBS

Screwdrivers Sets



32810MR 10Pc. Interchangeable Ratchet Screwdriver Set

\$48.66

Reversible Ratchet, 1/4" & 5/16" Bit Holder
 Power Bits 3" Length, PH0xSL4, PH1xSL5, PH2xSL6, PH3xSL8, Torx 10x15, Hex 2x2.5mm, 3x4mm, 5x6mm
 0.88 LBS



A31401MR

\$608.43

96Pc. Screwdriver Set METRIC W/Display

6ea. of Phillips Head No. 0x2-3/8"L, No. 1x3-1/8"L, No. 1x4"L, No. 2x1-1/2"L,
 Slotted Head 1/8"x3"L, 5/32"x4"L, 7/32"x3"L, 7/32"x4"L, 7/32"x5"L, 1/4"x1-1/2"L, 1/4"x4"L, 1/4"x6"L, 5/16"x6"L
 20.90 LBS



Insulated Screwdrivers

1471



Insulated Screwdriver Phillips Head

Item	Size	LBS	\$
14710003	#0 1/8" x 3"	0.08	5.90
14710104	#1 3/16" x 4"	0.12	6.91
14710204	#2 1/4" x 4"	0.17	9.23
14710306	#3 5/16" x 6"	0.30	13.04

1472



Insulated Screwdriver Slotted Head

Item	Size	LBS	\$
14720303	1/8" x 3"	0.08	5.90
14720404	3/16" x 4"	0.10	6.25
14720807	5/16" x 7"	0.16	11.37
14725505	7/32" x 5"	0.19	7.33
14726506	1/4" x 6"	0.31	8.63

1474



Insulated Screwdriver Square Head

Item	Size	LBS	\$
14740105	3/16" x 5"	0.16	7.75
14740206	1/4" x 6"	0.19	10.19

1478



Insulated Screwdriver Pozidriv Head

Item	Size	LBS	\$
14780003	#0 1/8" x 3"	0.08	5.90
14780104	#1 3/16" x 4"	0.12	6.91
14780204	#2 1/4" x 4"	0.17	9.23
14780306	#3 5/16" x 6"	0.30	13.04

7Pc. Insulated POZ+SLT Head Screwdriver Set



30607MR

\$65.57

Pozidriv Head No. 1x3/16"x4"L,
No.2x1/4"x4"L, No.3x5/16"x6"L
Slotted Head
3/16"x4"L, 7/32"x5"L, 1/4"x6"L,
5/16"x8"L
1.90 LBS

7Pc. Insulated PH+SLT Head Screwdriver Set



30617MR

\$65.57

Phillips Head
No.1x3/16"x4"L, No.2x1/4"x4"L,
No.3x5/16"x6"L
Slotted Head
3/16"x4"L, 7/32"x5"L, 1/4"x6"L,
5/16"x8"L
1.90 LBS

INSULATED TOOLS - 1,000VOLT RATED & IEC CERTIFIED

Many of these items are available with Hang Tags for 6% additional charge

Precision Screwdrivers



1431

Phillips Precision Screwdriver

Item	Size	LBS	\$
14311003	#0 75MM	0.03	4.76
14311015	#0 40MM	0.03	4.76
14311103	#1 75MM	0.04	4.76
14311115	#1 40MM	0.04	4.76
14312003	#00 75MM	0.02	4.25
14312015	#00 40MM	0.02	4.25
14313003	#000 75MM	0.03	4.25
14313015	#000 40MM	0.04	4.25



1432

Slotted Precision Screwdriver

Item	Size	LBS	\$
14320615	0.6 x 40MM	0.02	4.81
14320815	0.8 x 40MM	0.02	4.81
14321003	1 x 75MM	0.02	5.13
14321015	1 x 40MM	0.02	4.81
14321503	1.5 x 75MM	0.02	5.13
14321515	1.5 x 40MM	0.02	4.81
14321803	1.8 x 75MM	0.02	5.13
14321815	1.8 x 40MM	0.02	4.81
14322003	2 x 75MM	0.02	5.13
14322015	2 x 40MM	0.02	4.53
14322503	2.5 x 75MM	0.03	4.88
14322515	2.5 x 40MM	0.03	4.53
14323003	3 x 75MM	0.03	4.88
14323015	3 x 40MM	0.03	4.53
14323503	3.5 x 75MM	0.04	4.88
14323515	3.5 x 40MM	0.03	4.53
14324003	4 x 75MM	0.04	4.88
14324015	4 x 40MM	0.04	4.53



1433

Torx Precision Screwdriver

Item	Size	LBS	\$
14330403	T4x75MM	0.02	4.88
14330415	T4x40MM	0.02	4.53
14330503	T5x75MM	0.02	4.88
14330515	T5x40MM	0.02	4.53
14330603	T6x75MM	0.02	4.88
14330615	T6x40MM	0.04	4.53
14330703	T7x75MM	0.04	4.88
14330715	T7x40MM	0.04	4.53
14330803	T8x75MM	0.04	5.12
14330815	T8x40MM	0.04	4.53
14330902	T9x50MM	0.02	4.88
14330903	T9x75MM	0.02	5.12
14331002	T10x50MM	0.02	4.88
14331003	T10x75MM	0.02	5.12
14331502	T15x50MM	0.02	4.88
14331503	T15x75MM	0.04	5.12
14332002	T20x50MM	0.04	4.88
14332003	T20x75MM	0.04	5.12



Many of these items are available with Hang Tags for 6% additional charge

Precision Screwdriver Sets



32108MR
\$41.00
8Pc. PH&SL Head Precision Screwdriver Set

Precision Screwdriver with 40mm Length:
 Phillips Head No.000, No.00, No.0, No.1
 Slotted Head 1.5, 2.0, 2.5, 3.0mm
 0.53 LBS

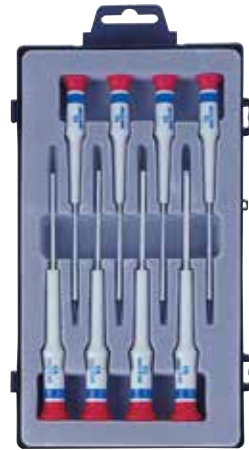

32218MR
\$47.07
8Pc. Slotted Head Precision Screwdriver Set

Precision Screwdriver with 75mm Length:
 Slotted Head 1.0, 1.5, 1.8, 2.0, 2.5, 3.0, 3.5, 4.0mm
 0.71 LBS

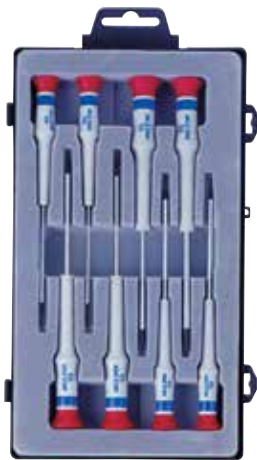

32118MR
\$44.38
8Pc. PH&SL Head Precision Screwdriver Set

Precision Screwdriver with 75mm Length:
 Phillips Head No.000, No.00, No.0, No.1
 Slotted Head 1.5, 2.0, 2.5, 3.0mm
 0.71 LBS



32309PR
\$46.95
9Pc. Torx Head Precision Screwdriver Set

Precision Screwdriver Torx Head
 40mm Length: T4,T5,T6,T7,T8,
 50mm Length: T9,T10,T15,T20
 0.57 LBS



32209MR
\$50.01
9Pc. Slotted Head Precision Screwdriver Set

Precision Screwdriver with 40mm Length:
 Slotted Head 0.8, 1.0, 1.5, 1.8, 2.0, 2.5, 3.0, 3.5, 4.0mm
 0.57 LBS



32607MR
\$35.82
8Pc. PH&SL+Torx Precision Screwdriver Set

Precision Screwdriver Handle 4-1/2"
 Phillips + Slotted Head:
 No.00x2.0, No.0x3.0, No.1x4.0
 Torx Head: T6xT10, T7xT15, T8xT20,
 T9xT15
 0.49 LBS

Nut Spinners & Power Bits & Handles



1450

Nut Spinner Round Shank METRIC

Item	Size	LBS	\$
1450-04	4MM	0.15	9.95
1450-45	4.5MM	0.15	9.95
1450-05	5MM	0.17	9.95
1450-55	5.5MM	0.17	9.95
1450-06	6MM	0.17	9.95
1450-07	7MM	0.17	12.44
1450-08	8MM	0.22	12.44
1450-09	9MM	0.23	12.44
1450-10	10MM	0.23	14.66
1450-11	11MM	0.35	14.66
1450-12	12MM	0.35	16.25
1450-13	13MM	0.35	16.25



5451

Nut Spinner Hollow Shaft SAE

Item	Size	LBS	\$
5451-06	3/16"	0.17	11.29
5451-08	1/4"	0.18	12.37
5451-10	5/16"	0.18	12.37
5451-11	11/32"	0.18	12.37
5451-12	3/8"	0.24	13.01
5451-14	7/16"	0.24	13.12
5451-16	1/2"	0.33	13.82

7Pc. Hollow Nut Spinner SAE Set W/Tray **9-30107SR** \$84.65



Nut Spinner Hollow Shaft
3/16", 1/4", 5/16", 11/32", 3/8", 7/16", 1/2"x3"L
1.87 LBS

1317

1/4" Long Head Double End Power Bits 7"L

Item	Size	LBS	\$
1317012PN	PH1xPH2	0.10	4.72
13171012ZN	PZ2xPZ1	0.10	4.72
1317046SN	SL4xSL6	0.10	4.72
1317057SN	SL5xSL7	0.10	4.72
1317115TN	T10xT15	0.10	4.72
1317225TN	T20xT25	0.10	4.72
1317340TN	T30xT40	0.10	4.72
1317401PN	SL4xPH1	0.10	4.72
131744BHN	B4xH4	0.10	4.72
1317501ZN	SL5xPZ1	0.10	4.72
131755BHN	B5xH5	0.10	4.72
1317602PN	SL6xPH2	0.10	4.72
131766BHN	B6xH6	0.10	4.72
1317702ZN	SL7xPZ2	0.10	4.72

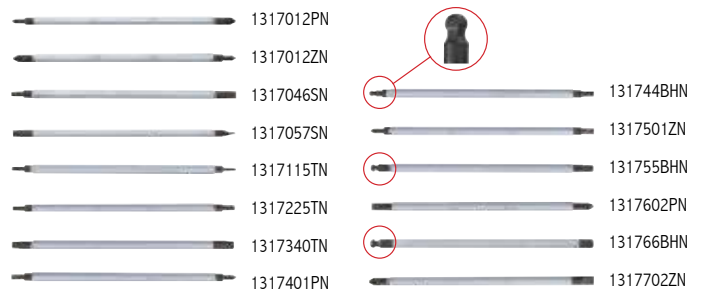

91232

Screwdriver Handle PP+PtR

Item	Size	LBS	\$
91232	5-1/4"	0.18	6.55



32501PR \$10.80

2Pc. Screwdriver handle W/ SLT+PHL Power bit 91232 + 1317602PN

0.30 LBS



Reversible Screwdriver Sets



11Pc. Reversible Screwdriver Set

32518MR

\$62.00

2 line like
Screwdriver Handle 5-1/4"
Power Bits 7" Length, Phillips 1x2
Pozidriv 1x2, Slotted 4x6, 5x7
Torx 10x15, 20x25, 30x40
Hex 4x4, 5x5, 6x6mm
1.54 LBS



11Pc. Reversible Screwdriver Set

32518MR01

\$62.00

Screwdriver Handle
5-1/4" Power Bits 7" Length, Torx 10x15, 20x25, 30x40
Phillips+Slotted 1x4, 2x6, Hex 4x4, 5x5, 6x6
Slotted+Pozidriv 5x1, 7x2mm
1.54 LBS



11Pc. Reversible Screwdriver Set

32518MR02

\$62.00

Screwdriver Handle 5-1/4" Power
Bits 7" Length
Torx 10x15, 20x25, 30x40
Phillips 1x2
Phillips+Slotted 1x4, 2x6
Hex 4x4, 5x5, 6x6
Slotted 5x7mm
1.54 LBS

Bit Sets



43Pc. Impact Driver Tool Set SAE+METRIC W/Eva Foam

9-4143FRE

\$120.25

1/2" DR IMPACT DRIVER, BIT HOLDERS: 5/16" & 10mm, 10mm Hex Bits: H5, H6, H7, H8, H10, H12
Spline Bits: M6, M8, M10, M12, 10mm Torx Bits: T30, T40, T45, T50, T55, T60
5/16" Hex Bits: H3, H4, H5, H6, H7, H8, H10, H12, 5/16" Torx Bits: T15, T20, T25, T30, T40, T45, T50
5/16" Phillips Bits 36mm: No. 2, No. 3, 5/16" Phillips Bits 80mm: No. 2, No. 3
5/16" Slotted Bits 36mm: 9x1.6MM, 11x2.0MM, 5/16" Slotted Bits 80mm: 8x1.6MM, 10x1.6MM
30.36 LBS



50Pc. Hex Size Shank Driver Bits Set

1050CQ

\$62.12

1025S 4.0x2, 5.5x2, 6.5x2
1025P PH1x2, PH2x2, PH3x2
1025Z PZ1x2, PZ2x2, PZ3x2
1025T T6, T7, T8, T9, T10, T15, T20,
T25, T27, T30, T40x2
1025H H2, H3, H4, H5, H6, H7, H8
1025U T7, T8, T9, T10, T15, T20, T25,
T27, T30, T40 x2 750-60 2141
1.10 LBS

7Pc. Tamper Resistant Bits & L-Type Holder Set

2138PR

\$15.51

Tamper Resistant Bits
2,3,4,5,6,7,8mm
0.52 LBS



1/4" 3Pc. Hexagon Head Bits Set

1003MQ

\$1.72

1/4" Hexagon Head Bits
25mm Length
4mm, 5mm, 6mm
0.05 LBS



1/4" 3Pc. Slotted Head Bits Set

1003LQ

\$2.28

1/4" Slotted Head Bits
25mm Length
4.5x0.6mm 6.5x1.2mm 8.0x1.2mm
0.05 LBS



1/4" 3Pc. Torx Head Bits Set

1003TQ

\$2.06

1/4" Torx Head Bits
25mm Length
T8, T10, T15
0.05 LBS



1/4" 3Pc. Phillips Head Bits Set

1003PQ

\$1.72

1/4" Phillips Head Bits
25mm Length
#1, #2, #3
0.05 LBS



1/4" 3Pc. Pozidriv Head Bits Set

1003ZQ

\$1.72

1/4" Pozidriv Head Bits
25mm Length
#1, #2, #3
0.05 LBS



1/4" 3Pc. Torx Head Bits Set

1003TQ01

\$2.06

1/4" Torx Head Bits
25mm Length
T20, T25, T30
0.05 LBS



1/4" Bits

1025P



1/4" Phillips Head Bit 25MML

Item	Size	Min. Pkg	LBS	\$
102500P	#0	20	0.01	1.23
102501P	#1	20	0.01	1.23
102502P	#2	20	0.01	1.23
102503P	#3	20	0.01	1.23

1025R



1/4" Square Head Bit 25MML

Item	Size	Min. Pkg	LBS	\$
102500R	#0	20	0.01	1.23
102501R	#1	20	0.01	1.23
102502R	#2	20	0.01	1.23
102503R	#3	20	0.01	1.23

102512P

1/4" Phillips Head Drywall Type Bit



Item	Size	Min. Pkg	LBS	\$
102512P	25MML	20	0.01	1.23

1025U

1/4" Torx Head Tamper Resistant Type Bit 25MML



Item	Size	Min. Pkg	LBS	\$
102507U	T7	20	0.01	1.58
102508U	T8	20	0.01	1.58
102509U	T9	20	0.01	1.58
102510U	T10	20	0.01	1.58
102515U	T15	20	0.01	1.58
102520U	T20	20	0.01	1.58
102525U	T25	20	0.01	1.58
102527U	T27	20	0.01	1.58
102530U	T30	20	0.01	1.58
102540U	T40	20	0.01	1.58

1025S



1/4" Slotted Head Bit 25MML

Item	Size	Min. Pkg	LBS	\$
102503S1	3.0x0.5mm	20	0.01	1.23
102535S1	3.5x0.6mm	20	0.01	1.23
102504S1	4.0x0.5mm	20	0.01	1.23
102504S2	4.0x0.8mm	20	0.01	1.23
102545S1	4.5x0.6mm	20	0.01	1.23
102505S1	5.0x0.8mm	20	0.01	1.23
102555S1	5.5x0.8mm	20	0.01	1.23
102555S2	5.5x1.0mm	20	0.01	1.23
102506S1	6.0x1.0mm	20	0.01	1.23
102565S1	6.5x1.2mm	20	0.01	1.23
102507S1	7.0x1.2mm	20	0.01	1.23
102508S1	8.0x1.2mm	20	0.01	1.23
102508S2	8.0x1.6mm	20	0.01	1.23

1025T

1/4" Torx Head Bits 25MML



Item	Size	Min. Pkg	LBS	\$
102506T	T6	20	0.01	1.58
102507T	T7	20	0.01	1.58
102508T	T8	20	0.01	1.58
102509T	T9	20	0.01	1.58
102510T	T10	20	0.01	1.58
102515T	T15	20	0.01	1.58
102520T	T20	20	0.01	1.58
102525T	T25	20	0.01	1.58
102527T	T27	20	0.01	1.58
102530T	T30	20	0.01	1.58
102540T	T40	20	0.01	1.58

1025Z

1/4" Pozidriv Type Bit 25MML



Item	Size	Min. Pkg	LBS	\$
102501Z	#1	20	0.01	1.23
102502Z	#2	20	0.01	1.23
102503Z	#3	20	0.01	1.23

Power Bits & Hex Keys

7300PP



1/4" Double Phillips Head Long Power Bits

Item	Size	Length	Min. Pkg	LBS	\$
734501P	#1	45MM	10	0.02	1.53
734502P	#2	45MM	10	0.02	1.53
734503P	#3	45MM	10	0.02	1.53
736501P	#1	65MM	10	0.03	1.96
736502P	#2	65MM	10	0.03	1.96
736503P	#3	65MM	10	0.03	1.96
731101P	#1	110MM	10	0.06	2.39
731102P	#2	110MM	10	0.06	2.39
731103P	#3	110MM	10	0.06	2.39
731502P	#2	150MM	10	0.07	2.95
731503P	#3	150MM	10	0.07	2.95

1145M



Short Arm Hex Key with Allen Head Satin

Item	Size	Min. Pkg	LBS	\$
114515M	1.5MM	10	0.01	1.90
114502M	2MM	10	0.01	2.10
114525M	2.5MM	10	0.01	2.16
114503M	3MM	10	0.01	2.27
114504M	4MM	10	0.01	2.41
114505M	5MM	10	0.03	3.10
114555M	5.5MM	10	0.05	3.32
114506M	6MM	10	0.06	3.43
114507M	7MM	10	0.09	3.57
114508M	8MM	10	0.13	3.84
114510M	10MM	10	0.23	5.26

7400PP



1/4" Double Phillips Head Short Power Bits

Item	Size	Length	Min. Pkg	LBS	\$
745002P	#2	50MM	10	0.20	1.64
747502P	#2	75MM	10	0.30	2.00
747503P	#3	75MM	10	0.40	2.00
741002P	#2	100MM	10	0.50	2.38
741502P	#2	150MM	10	0.80	2.94



8Pc. Hex Key Set 2-10mm Knife Type METRIC

20218MR

\$23.12

Hex Key Set 2, 2.5, 3, 4, 5, 6, 8, 10mm
0.73 LBS

1300PN



1/4" Long Head Double End Power Bits

Item	Size	Length	Min. Pkg	LBS	\$
134501P	#1	45MM	10	0.20	2.03
134502P	#2	45MM	10	0.20	2.03
134503P	#3	45MM	10	0.20	2.03
136501P	#1	65MM	10	0.30	2.64
136502P	#2	65MM	10	0.30	2.64
136503P	#3	65MM	10	0.30	2.64
131101P	#1	110MM	10	0.60	3.24
131102P	#2	110MM	10	0.60	3.24



9Pc. Hex Key Set 1.5-10mm METRIC W/Holder

20219MR

\$26.29

Hex Key 1.5, 2, 2.5, 3, 4, 5, 6, 8, 10mm
0.73 LBS



Hex Key Sets

1125S

Extra Long Hex Key W/Allen Head Satin SAE 6Pt.



Item	Size	LBS	\$
112504S	1/8"	0.17	3.57
112505S	5/32"	0.04	3.74
112506S	3/16"	0.06	3.89
112508S	1/4"	0.11	4.47
112510S	5/16"	0.22	5.99
112512S	3/8"	0.40	8.36
112516S	1/2"	0.63	14.68
112518S	9/16"	0.99	19.19

1125M

Extra Long Hex Key W/Allen Head Satin METRIC 6Pt



Item	Size	LBS	\$
112515M	1.5MM	0.01	2.79
112502M	2MM	0.01	3.10
112525M	2.5MM	0.01	3.36
112503M	3MM	0.01	3.74
112504M	4MM	0.03	3.74
112505M	5MM	0.07	3.98
112506M	6MM	0.11	4.44
112507M	7MM	0.17	5.03
112508M	8MM	0.22	6.02
112510M	10MM	0.40	8.40
112512M	12MM	0.63	15.41
112514M	14MM	0.99	20.39
112517M	17MM	1.69	25.40
112519M	19MM	1.89	35.96



8Pc. Extra Long Hex Key Set 1/8" - 9/16" SAE W/Tray

20208SR01

\$56.83

Extra Long Arm Hex Key 1/8", 5/32", 3/16", 1/4", 5/16", 3/8", 1/2", 9/16" 2.76 LBS



8Pc. Extra Long Hex Key Set 3-14mm METRIC W/Tray

20208MR01

\$56.83

Extra Long Arm Hex Key 3, 4, 5, 6, 8, 10, 12, 14mm 2.76 LBS



10Pc. Extra Long Hex Key Set 3-17mm METRIC W/Metal Box

20210MR

\$103.37

Extra Long Arm Hex Key 3,4,5,6,7,8,10,12,14,17mm 1.04 LBS



8Pc. Extra Long Hex Key Set 2-10mm METRIC

20208MR

\$29.73

Extra Long Arm Hex Key 2, 2.5, 3, 4, 5, 6, 8, 10mm 0.95 LBS



9Pc. Extra Long Hex Key Set 1.5-10mm METRIC W/Holder

20209MR

\$30.89

Extra Long Arm Hex Key 1.5, 2, 2.5, 3, 4, 5, 6, 8, 10mm 0.97 LBS

Long Arm Ball Point Hex Keys & Star L-Wrenches

1130S



Long Arm Hex Key W/Ball Point SAE Satin

Item	Size	LBS	\$
113003S	3/32"	0.01	3.36
113004S	1/8"	0.01	3.47
113005S	5/32"	0.03	3.47
113006S	3/16"	0.05	3.74
113007S	7/32"	0.07	4.11
113008S	1/4"	0.09	4.20
113010S	5/16"	0.18	5.84
113012S	3/8"	0.30	8.20

1130M

Long Arm Hex Key W/Ball Point METRIC Satin

Item	Size	LBS	\$
113015M	1.5MM	0.01	2.89
113002M	2MM	0.01	3.16
113025M	2.5MM	0.01	3.32
113003M	3MM	0.01	3.43
113004M	4MM	0.03	3.57
113005M	5MM	0.05	3.89
113006M	6MM	0.09	4.16
113008M	8MM	0.18	5.74
113010M	10MM	0.31	8.36

1143



Star L-Wrench Satin

Item	Size	LBS	\$
114310	T10	0.01	2.55
114315	T15	0.01	2.76
114320	T20	0.01	2.76
114325	T25	0.02	2.76
114327	T27	0.03	2.76
114330	T30	0.05	2.96
114340	T40	0.08	3.20
114345	T45	0.12	4.00
114350	T50	0.17	4.67

1147



Star L-Wrench Tamper Resistant Type Satin

Item	Size	LBS	\$
114710	T10	0.01	2.96
114710	T15	0.01	2.96
114720	T20	0.01	3.01
114725	T25	0.02	3.20
114727	T27	0.03	3.20
114730	T30	0.05	3.20
114740	T40	0.08	3.50
114745	T45	0.12	4.26
114750	T50	0.17	4.90

Ball Point Hex Key Sets



7Pc. Long Arm Ball Point Hex Key Set 3/32"-3/8" SAE

20107SR

\$26.86

Long Arm Hex Key With Ball Point Head
3/32", 1/8", 5/32", 3/16", 1/4", 5/16", 3/8"
0.79 LBS



7Pc. Long Arm Ball Point Hex Key Set 2.5-10MM METRIC

20107MR01

\$26.86

Long Arm Hex Key With Ball Point Head
2.5, 3, 4, 5, 6, 8, 10mm
0.81 LBS



8Pc. Extra Long Ball Point Hex Key Set 2-10MM METRIC

20108MR

\$32.70

Extra Long Arm Hex Key With Ball Point Head
2, 2.5, 3, 4, 5, 6, 8, 10mm
0.95 LBS



9Pc. Extra Long Ball Point Hex Key Set 1.5-10MM METRIC

20109MR

\$35.04

Extra Long Arm Hex Key With Ball Point Head
1.5, 2, 2.5, 3, 4, 5, 6, 8, 10mm
0.97 LBS

L-Wrench Ball Hex Key Sets



6Pc. L-Handle Ball Point Hex Key Set 3-8MM METRIC

22106MR

\$57.05

L-Type Hex With Ball Point Head Wrenches
3,4,5,6,7,8mm
1.50 LBS



6Pc. L-Handle Torx Hex Key Set T10-T40

22306PR

\$54.75

L-Type Torx Head
Tamper Resistant Type Wrenches
T10,T15,T20,T25,T30,T40
1.01 LBS



8Pc. L Handle Hex Key Set 2-10MM METRIC

22208MR

\$70.61

L-Type Hex Head Wrenches
2,2.5,3,4,5,6,8,10mm
2.14 LBS

Star Wrench Sets



7Pc. Star Wrench Set T10-T40

20307PR

\$16.36

Star L-Wrenches Standard Torx Head
T10,T15,T20,T25,T27,T30,T40
0.29 LBS



8Pc. Star Wrench Set T9-T40 Knife Type

20308PR

\$21.02

Star L-Wrenches Standard Torx Head
T9,T10,T15,T20,T25,T27,T30,T40
0.44 LBS



9Pc. Star Wrench Set T10-T50

20309PR

\$23.36

Star L-Wrenches Standard Torx Head
T10,T15,T20,T25,T27,T30,T40,T45,T50
0.66 LBS



7Pc. Star Wrench Set W/ Tamper Resistant T10-T40

20407PR

\$18.11

Star L-Wrenches Standard Torx Head
Tamper Resistant Type
T10,T15,T20,T25,T27,T30,T40
0.29 LBS



9Pc. Star Wrench Set W/ Tamper Resistant T10-T50

20409PR

\$23.36

Star L-Wrenches Standard Torx Head
Tamper Resistant Type
T10,T15,T20,T25,T27,T30,T40,T45,T50
0.75 LBS



9Pc. Extra Long Star Wrench W/ Tamper Resistant T10-T50

20419PR

\$36.80

Star L-Wrenches Extra Long Torx Head
Tamper Resistant Type
T10,T15,T20,T25,T27,T30,T40,T45,T50
0.99 LBS

Pliers & Cutting

Comfortable molded handles • Precision cutting edges
Quality locking selection • Custom sets



- Combination Pliers
- Diagonal Cutting Nippers
- Long Nose Pliers
- Bent Nose Pliers
- End Cutting Pliers
- Slip Joint Pliers
- Groove Joint Pliers
- Wire Stripping Pliers
- Circle Pliers
- Insulated Pliers
- Locking Pliers
- Miniature Adjustable Long Nose Pliers
- C-Clamp Adjustable Pliers
- Pliers Sets
- Crimping Tools
- Aviation Tin Snips
- Offset Tin Snips
- Figure Tin Snips
- Straight Pattern Snips
- Duckbill Circular Pattern Snips
- Bolt Cutter
- Steel Strap Cutter
- Gear Pullers



Combination Pliers



6111

European Style Combination Pliers

6111-06	6-1/2"	0.44 LBS	\$22.17
6111-07	7-1/2"	0.57 LBS	\$22.67
6111-08	8-1/4"	0.75 LBS	\$27.58



6112

High Leverage Combination Pliers

6112-09A	9"	0.79 LBS	\$44.33
----------	----	----------	---------



6114

Miniature Lineman's Pliers

6114-05	5-1/2"	0.22 LBS	\$14.07
---------	--------	----------	---------

Diagonal Cutting Nippers



6211

European Style Line Diagonal Cutting Nippers

6211-06	6-1/2"	0.40 LBS	\$28.38
---------	--------	----------	---------



6213

Asian Style Line Diagonal Cutting Nippers

6213-06	6-1/2"	0.31 LBS	\$32.35
---------	--------	----------	---------



6214

Miniature Diagonal Cutting Nippers

6214-45	4-1/2"	0.23 LBS	\$14.07
6214-05	5"	0.21 LBS	\$15.14



6231

Euro Style Heavy Duty Diagonal Cutting Nippers

6231-07	7-1/2"	0.48 LBS	\$24.08
6231-08	8"	0.62 LBS	\$25.33

Long Nose Pliers



6314
Miniature Long Nose Pliers
6314-05 5-1/4" 0.23 LBS \$13.46



6313
Japanese Long Nose Pliers
6313-06 6-1/2" 0.31 LBS \$21.95

6311
European Style Long Nose Pliers
6311-06 6-1/2" 0.31 LBS \$21.43
6311-08 8" 0.48 LBS \$25.55

Bent Nose Pliers



6331
European Style Bent Nose Pliers
6331-06 6-1/2" 0.35 LBS \$24.26
6331-08 8" 0.44 LBS \$26.62



6334
Miniature Bent Nose Pliers
6334-05 5" 0.23 LBS \$16.47

End Cutting Pliers



6411
European Style End Cutting Pliers
6411-06 6-1/2" 0.53 LBS \$23.64



6431
European Style End Cutting Pliers
6431-10G 10" 0.98 LBS \$25.10
6431-11G 11" 1.12 LBS \$25.10

Slip Joint Pliers

6463

Slip Joint Adjustable Pliers 2 Position
6463-08G 8" 0.64 LBS \$15.88



Stripping Pliers

6711

Stripping Plier with Spring and Adjusting Screw
6711-06 6" 0.35 LBS \$27.07



Groove Joint Pliers

6516

German Style Groove Joint Pliers
6516-10G 10" 0.66 LBS \$35.22



6511

Groove Joint Pliers

6511-10A	10"	0.88 LBS	\$35.22
6511-10G	10"	0.88 LBS	\$38.49
6511-13G	13"	1.78 LBS	\$45.54
6511-17G	17"	2.53 LBS	\$64.21

6511-A



6511-G



IT'S GOOD TO BE THE KING.

Circlip Pliers

Top tier pliers that take all challenges and meet the highest requirements for quality, ease of use and efficiency

67SB

Circlip Plier Angled for External Retaining Rings

67SB-07G	7"	0.29 LBS	\$23.18
----------	----	----------	---------

68HB

Circlip Plier Angled for Internal Retaining Rings

68HB-05G	5"	0.26 LBS	\$22.51
68HB-07G	6-3/4"	0.29 LBS	\$23.68
68HB-10G	10"	0.64 LBS	\$27.00

68HS

Circlip Plier Straight for Internal Retaining Rings

68HS-05G	5"	0.28 LBS	\$21.11
68HS-07G	7"	0.29 LBS	\$22.51
68HS-10G	10"	0.64 LBS	\$29.76

68SS

Circlip Plier Straight for External Retaining Rings

68SS-05G	5"	0.28 LBS	\$21.11
68SS-07G	7"	0.29 LBS	\$22.92
68SS-10G	10"	0.64 LBS	\$29.76

68SB

Circlip Plier Angled for External Retaining Rings

68SB-05G	5"	0.26 LBS	\$22.51
68SB-07G	6-3/4"	0.29 LBS	\$23.68
68SB-10G	10"	0.64 LBS	\$27.00

67HB

Circlip Plier Angled for Internal Retaining Rings

67HB-07G	7"	0.29 LBS	\$23.18
----------	----	----------	---------

67SS

Circlip Plier Straight for External Retaining Rings

67SS-07G	7"	0.29 LBS	\$22.00
----------	----	----------	---------



Insulated Pliers



6116-A
Insulated Combination Pliers
 6116-07A 7-1/2" 0.64 LBS \$43.10
 6116-08A 8" 0.85 LBS \$43.58



6318-08A
Insulated Long Nose Pliers
 6318-08A 8-1/4" 0.55 LBS \$47.38



6216-06A
Insulated Diagonal Cutting Pliers
 6216-06A 6-1/2" 0.50 LBS \$38.44



6336-08A
Insulated Bent Nose Pliers
 6336-08A 8" 0.55 LBS \$43.33



6236-07A
Insulated Diagonal Cutting Pliers (Heavy Duty)
 6236-07A 7-1/2" 0.62 LBS \$43.33



6146-08A
Insulated Cable Cutting Pliers
 6146-08A 8-1/4" 0.79 LBS \$77.40

INSULATED TOOLS - 1,000VOLT RATED & IEC CERTIFIED

Insulated Pliers



6716-06A
 Insulated Wire Stripping Pliers
 6716-06A 6-1/4" 0.45 LBS \$47.92



6516-10A
 Insulated Water Pump Pliers
 6516-10A 10" 0.93 LBS \$47.92

INSULATED TOOLS - 1,000VOLT RATED & IEC CERTIFIED

Lock Grip Pliers

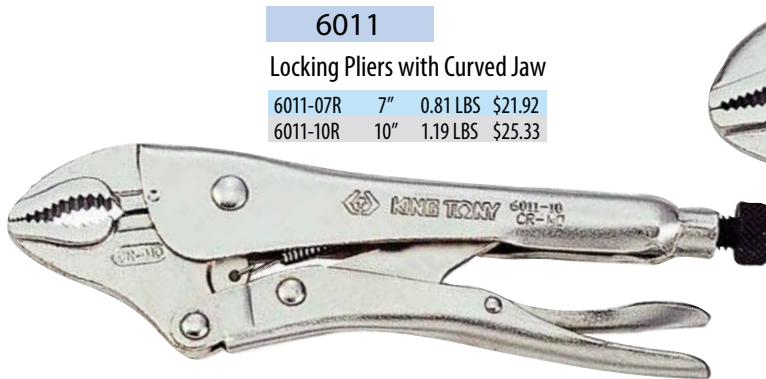

6011
 Locking Pliers with Curved Jaw
 6011-07R 7" 0.81 LBS \$21.92
 6011-10R 10" 1.19 LBS \$25.33



6031
 Locking Pliers with Straight Jaw
 6031-07R 7" 0.86 LBS \$21.92
 6031-10N 10" 1.26 LBS \$25.33

C-Clamp Grip Pliers



6615
 C-Clamp Adjustable Plier
 6615-11 11" 1.74LBS \$45.63



6625
 C-Clamp Adjustable Plier W/Moving Jaw
 6625-11 11" 1.85LBS \$51.60

Miniature Long Nose Pliers

6315

Miniature Adjustable Long Nose Pliers

6315-06 6" 0.45LBS \$26.73



European Type Pliers Set



42104GP01

4Pc. European Type Pliers Set

\$113.72

- Combination Pliers 6-1/2"
- Diagonal Cutting Nipper 6-1/2"
- Long Nose Pliers 8"
- Groove Joint Pliers 10"
- 2.58 LBS

Circlip Pliers Set



42114GP

4Pc. Internal & External Circlip Pliers Set

\$113.72

- | | |
|-------------------------|--------------------------|
| Circlip Pliers | External retaining rings |
| Internal retaining ring | 7" Straight |
| 7" Straight | 6-3/4" Angled |
| 6-3/4" Angled | |
| 1.37 LBS | |



42116GP

6Pc. Internal & External Circlip Pliers Set

\$179.22

- | | |
|-------------------------|--------------------------|
| Circlip Pliers | External retaining rings |
| Internal retaining ring | 7" and 10" Straight |
| 7" and 10" Straight | 6-3/4" Angled |
| 6-3/4" Angled | |
| 1.37 LBS | |

Steel Strap Cutter



74900
Steel Strap Cutter
74900 12" 1.65 LBS \$47.53

Aviation Tin Snips



74010
Aviation Tin Snip Left Cut (Red)
74010 9-3/4" 0.83 LBS \$32.10



74020
Aviation Tin Snip Right Cut (Green)
74020 9-3/4" 0.83 LBS \$32.10



74030
Aviation Tin Snip Straight Cut (Yellow)
74030 10" 0.84 LBS \$32.10



74040
Aviation Tin Snip Notching (Yellow)
74040 9" 0.82 LBS \$32.10



74060
Aviation Tin Snip Long Cut (Orange)
74060 11-1/2" 0.99 LBS \$34.80



Offset Tin Snips



74150
Offset Tin Snip Left Cut (Red)
74150 9-1/4" 0.84 LBS \$35.27



74160
Offset Tin Snip Right Cut (Blue)
74160 9-1/4" 0.88 LBS \$33.59



74350
Offset Tin Snip Left Cut (Red)
74350 10" 1.15 LBS \$39.49



74360
Offset Tin Snip Right Cut (Blue)
74360 10" 1.15 LBS \$39.49



Figure Tin Snips



74250
Figure Tin Snip Left Cut (Red)
74250 10" 1.06 LBS \$35.27



74260
Figure Tin Snip Right Cut (Blue)
74260 10" 1.06 LBS \$35.27



74270
Figure Tin Snip Long Cut (Yellow)
74270 10" 1.06 LBS \$35.27



Straight Pattern Snips & Duckbill Circular Pattern Snips

74407-74416

Straight Pattern Snip

74407	7"	0.60 LBS	\$22.67
74408	8"	0.75 LBS	\$23.85
74410	10"	1.06 LBS	\$26.67
74412	12"	1.43 LBS	\$35.77
74414	14"	1.72 LBS	\$44.96
74416	16"	3.75 LBS	\$63.36



74607-74613

Duckbill Pattern Snip

74607	7"	0.55 LBS	\$22.95
74610	10"	1.01 LBS	\$27.00
74613	13"	1.59 LBS	\$41.00



Bolt Cutters

6131

Bolt Cutter

6131-12	12"	1.68 LBS	\$46.87
6131-14	14"	2.21 LBS	\$56.88
6131-18	18"	3.33 LBS	\$69.88
6131-24	24"	5.18 LBS	\$90.92
6131-30	30"	8.27 LBS	\$124.57
6131-36	36"	12.13 LBS	\$163.83
6131-42	42"	18.87 LBS	\$183.69



6131P01

Spare Blade for 6131

6131-12P01	12"	0.57LBS	\$21.39
6131-14P01	14"	0.88 LBS	\$25.91
6131-18P01	18"	1.87 LBS	\$31.87
6131-24P01	24"	1.92 LBS	\$41.39
6131-30P01	30"	2.76 LBS	\$56.64
6131-36P01	36"	4.08 LBS	\$74.50
6131-42P01	42"	6.83 LBS	\$105.74



J133

Bolt Cutter Angular Cut Flush Cutting

J133-14	14"	2.21 LBS	\$80.85
J133-36	36"	12.15 LBS	\$241.73
J131-14	NSN#5100-00-224-7055		
J133-36	NSN#5110-00-224-7057		

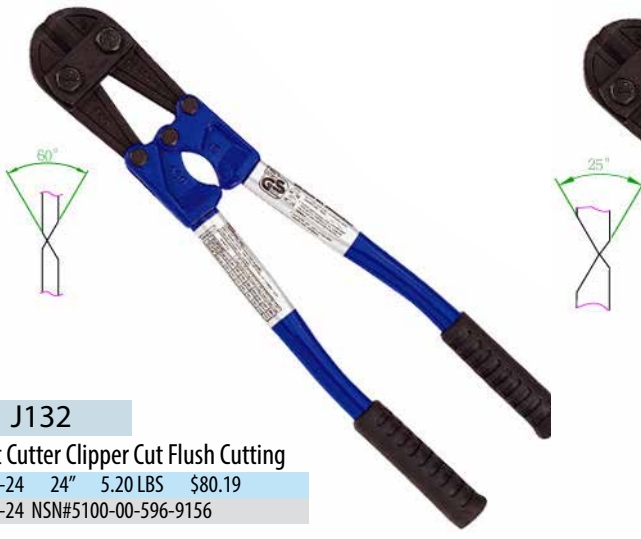

J132

Bolt Cutter Clipper Cut Flush Cutting

J132-24	24"	5.20 LBS	\$80.19
J132-24	NSN#5100-00-596-9156		



Crimping Tools



6721-10
Professional Crimping Tool
6721-10 9-3/4" 0.55 LBS \$41.67

FUNCTION:

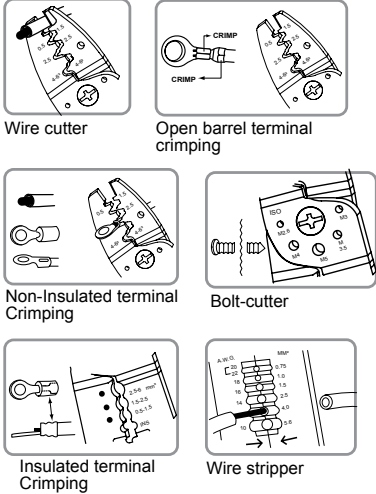

6731-09
Professional Crimping Tool
6731-09 6" 0.51LBS \$37.86

FUNCTION:

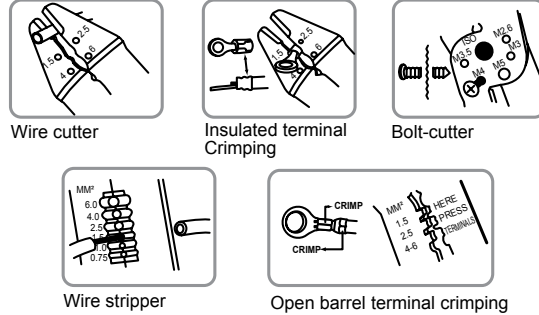

6741-06
Wire Stripper + Cutter
6741-06 6" 0.23 LBS \$21.82

FUNCTION:

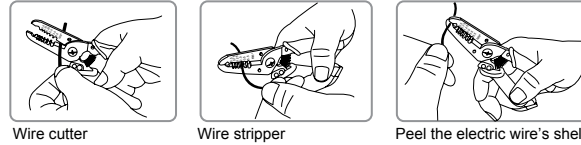

Gear Pullers



7962
Two Jaw Gear Puller

7962-03	3"	0.97 LBS	\$40.03
7962-04	4"	1.72 LBS	\$58.09
7962-06	6"	3.64 LBS	\$93.66
7962-08	8"	7.72 LBS	\$172.68
7962-12	12"	15.44 LBS	\$426.71



7963
Three Jaw Gear Puller

7963-03	3"	1.21 LBS	\$58.42
7963-04	4"	2.34 LBS	\$79.44
7963-06	6"	4.96 LBS	\$130.30
7963-08	8"	9.92 LBS	\$227.04
7963-12	12"	24.26 LBS	\$646.86

Striking Tools

PUNCHES & PUNCH SETS • FILES & SETS



Punches & Sets

761



Center Punch

Item	Size	LBS	\$
76103-04	3 x 100MM	0.07	5.53
76104-05	4 x 120MM	0.13	5.70
76105-06	5 x 150MM	0.26	5.83

762



Flat Chisel

Item	Size	LBS	\$
76213-04	13 x 100MM	0.15	6.76
76215-05	15 x 125MM	0.15	7.54
76217-06	17 x 150MM	0.32	8.28
76220-07	20 x 175MM	0.66	8.95
76223-08	23 x 200MM	0.66	10.35
76224-10	24 x 250MM	0.85	11.91
76226-12	26 x 300MM	1.43	16.62

763



Starter Punch

Item	Size	LBS	\$
76301-05	1 x 120MM	0.13	5.53
76302-05	2 x 120MM	0.13	5.70
76303-05	3 x 120MM	0.13	5.83
76304-05	4 x 120MM	0.13	6.76
76305-05	5 x 120MM	0.14	7.54
76306-05	6 x 120MM	0.14	8.28
76307-05	7 x 120MM	0.22	8.95
76308-05	8 x 120MM	0.22	10.35
76309-06	9 x 150MM	0.29	11.91
76310-06	10 x 150MM	0.26	16.62

764



Pin Punch

Item	Size	LBS	\$
76402-45	2 x 30MM	0.07	6.26
76403-05	3 x 40MM	0.07	6.26
76404-06	4 x 50MM	0.13	6.99
76405-65	5 x 55MM	0.16	7.42
76406-07	6 x 55MM	0.28	8.16
76408-08	8 x 60MM	0.29	8.47
76410-85	10 x 65MM	0.34	13.01
76412-09	12 x 70MM	0.78	16.08
76414-10	14 x 75MM	0.10	20.49



6Pc. Pin Punch Set

1006PR

\$47.46

Pin Punch: Ø2x30mm, Ø3x40mm, Ø4x50mm, Ø5x55mm, Ø6x55mm, Ø8x60mm
1.26 LBS



9Pc. Pin Punch Set

1009PR

\$90.08

Pin Punch: 2x30mm, 3x40mm, 4x50mm, 5x55mm, 6x55mm, 8x60mm, 10x65mm, 12x70mm, 14x75mm
3.68 LBS



10Pc. Pin+Center+ Starter Punch Set

1010PR

\$71.80

Pin Punch Ø2x30, Ø4x50, Ø5x55, Ø6x55
Center Punch Ø3x100mm, Ø4x120mm
Starter Punch Ø3x120, Ø6x120, Ø8x120
1.61 LBS

1/4" Dr. 2Pc. Type Magnetic Bit Holder Hex 60MML



750

Item	Size	LBS	\$
750-60	1/4"	0.05	4.68

Second Cut Files & Sets



5Pc. Second Cut File Set W/ Handles 8"

1005GQ
\$88.44

Flat, Half Round, Round, Square, Triangle W/Handle
1.76 LBS



5Pc. Second Cut File Set W/ Handles 10"

1015GQ
\$100.45

Flat, Half Round, Round, Square, Triangle W/Handle
2.70 LBS



91248/91249 Second Cut File Handles

Item	Size	LBS	\$
91248	8" 4-7/8"	0.15	8.34
91249	10" 4-7/8"	0.15	8.34



4Pc. Flat Chisel Set

11104PR10
\$64.26

Flat Chisel 5", 6", 8", 10"
2.12 LBS



75102G Flat Files W/Handle

Item	Size	LBS	\$
75102-08G	8"	0.43	12.50
75102-10G	10"	0.62	14.73



75202G Half Round Files W/Handle

Item	Size	LBS	\$
75202-08G	8"	0.39	15.47
75202-10G	10"	0.65	16.98



75302G Round Files W/Handle

Item	Size	LBS	\$
75302-08G	8"	0.25	10.55
75302-10G	10"	0.38	13.16



75402G Triangular Files W/Handle

Item	Size	LBS	\$
75402-08G	8"	0.37	14.05
75402-10G	10"	0.60	14.99



75502G Square Files W/Handle

Item	Size	LBS	\$
75502-08G	8"	0.28	12.50
75502-10G	10"	0.42	14.13



Tool Chests & Roll Cabinets

Portable Tool Chests • Roll Cabinets • Tool Carts
Tool Cabinet – Accessories



Powder coated for
surface protection

Ball bearing
drawer sides

Heavy gauge steel
reinforced framed

Central locking system

Drawer liners &
rubber mats

Full width
drawer pulls

Load casters
with locks

Portable Chests

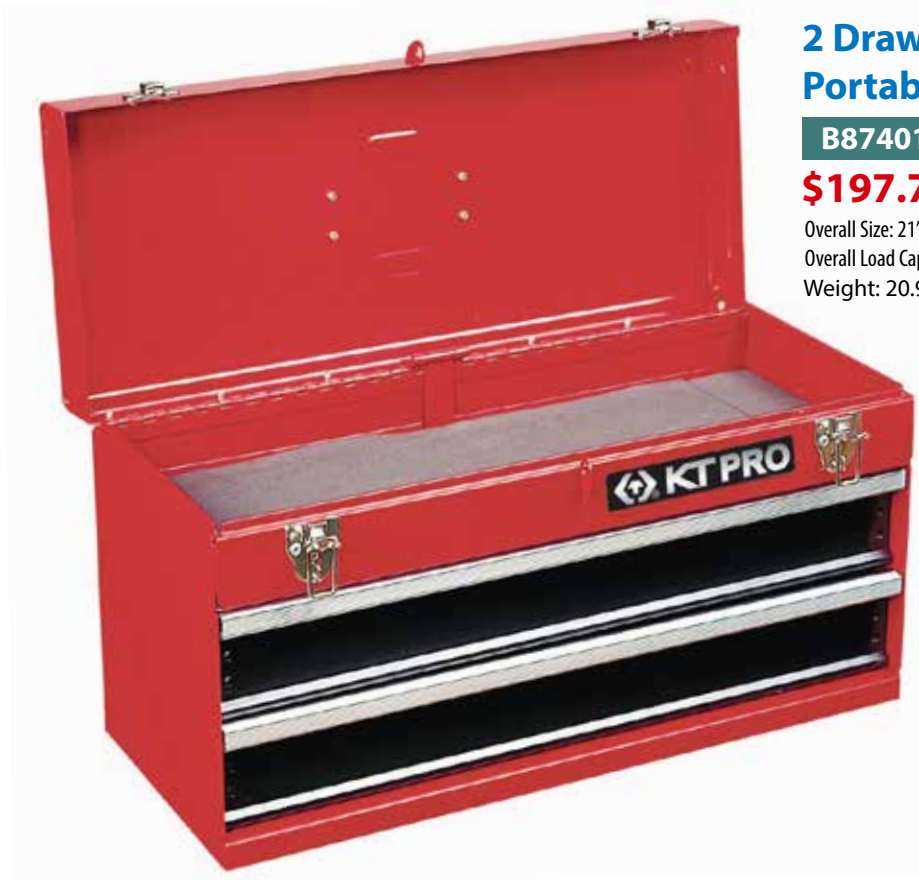

2 Drawer Slides Type Portable Tool Chest

B87401-2

\$197.73

Overall Size: 21"x8-5/8"x11-1/4"

Overall Load Capacity: 52.80LBS

Weight: 20.95LBS

Drawer Size 19-13/16"x7-5/8"x3"
Weight Capacity 17.60 LBS

3 Drawer Slides Type Portable Tool Chest

B87401-3

\$221.23

Overall Size: 21"x8-5/8"x11-1/4"

Overall Load Capacity: 70.40LBS

Weight: 24.03LBS



Drawer Size 19-13/16"x7-5/8"x2"
Weight Capacity 17.60 LBS



Portable Chests

3 Drawer Ball Bearing Type Tool Chest

B87421-3B

\$387.60

Overall Size: 26"x12"x9-7/8"

Overall Load Capacity:

110.00LBS

Weight: 34.18LBS



Top Drawer 22-3/8"x10-13/16"x1-15/16"
Weight Capacity 33.00 LBS

Bottom Two Drawers 22-3/8"x10-13/16"x2-15/16"
Weight Capacity 44.00 LBS



Upper Cabinet
25-7/16"x11-13/32x2-3/8"

Top 3 Small Drawers
6-11/16"x10-13/16"x1-15/16"
Weight Capacity 17.60 LBS

Middle Drawer
22-3/8"x10-13/16"x1-15/16"
Weight Capacity 33.00 LBS

Bottom Two Drawers
22-3/8"x10-13/16"x2-15/16"
Weight Capacity 44.00 LBS



6 Drawer Slides Type Tool Chest W/ Ball Bearing

B87411-6B \$561.00

Overall Size: 26"x12"x14-3/4" - Overall Load Capacity: 180.40LBS - Weight: 54.68LBS

Comes with a tool tray

Roll Cabinets



5 Drawer Ball Bearing Type Roll Cabinet

B87432-5B

\$1,155.41

Overall Size: 26-3/8"x18"x31-15/16"
Overall Load Capacity: 660.00LBS
Weight: 136.71LBS

Top Three Drawers
22-5/8"x15"x2-15/16"
Weight Capacity 55.00 LBS

Bottom Two Drawers
22-5/8"x15"x6"
Weight Capacity 66.00 LBS

Bottom Space Storage
23-11/16"x15-7/8"x9-1/4"
Weight Capacity 66.00 LBS

7 Drawer Ball Bearing Type Roll Cabinet

B87434-7B

\$1,276.50

Overall Size: 26-3/8"x18"x31-15/16"
Overall Load Capacity: 660.00LBS
Weight: 136.71LBS

Top Five Drawers
22-5/8"x15"x2-15/16"
Weight Capacity 55.00 LBS

Bottom Two Drawers
22-5/8"x15"x6"
Weight Capacity 66.00 LBS



Tool Carts

Drawer
22-3/8"x10-13/16"x2-15/16"
Weight Capacity 33.00 LBS Drawer



Plus Wheels
28"x16-1/8"x33-5/8"
Weight Capacity 66.00 LBS Caster

1 Drawer Tool Cart

B87441-1B

\$464.31

Overall Size: 28"x16-1/8"x29-1/2"
Overall Load Capacity: 660.00LBS
Weight: 52.92LBS

3 Drawer Ball Bearing Slide Tool Cart

B87441-3B

\$726.65

Overall Size: 28"x16-1/8"x29-1/2"
Overall Load Capacity: 660.00LBS
Weight: 72.77LBS

Top Drawer
22-3/8"x10-13/16"x1-15/16"
Weight Capacity 33.00 LBS Drawer



Bottom Two Drawers 22-3/8"x10-13/16"x2-15/16"
Weight Capacity 44.00 LBS Caster

Plus Wheels: 28"x16-1/8"x33-5/8"

Tool Cabinets Accessories

Drawer Dividers

Item	Size	Material	\$
B84732-22	22-19/32"x 14-1/2" x 1-19/32"	Steel	52.71
B84732-23	22-3/8"x10-7/16"x1-19/32"	Steel	49.76
B84732-24	22-7/16"x14-9/16"x1-19/32"	Plastic	10.00
B84732-26	22-7/16"x10-5/8"x1-19/32"	Plastic	18.25



B84732-22
B84732-23



B84732-24
B84732-26

Auto Tools



Engine Series • Undercar Series

Engine Series



9AA21 \$53.25
Curved Hose Clamp Pliers

- Use to remove and install spring clamp
- Swivel V jaw easy to hold clamp in position
- Suitable to fit many types of vehicles , especially Audi, Ford, Honda, Opel and VW
- 0.40 LBS

Item	Ø	Length
9AA21	18~53MM	8-1/2", 220MM

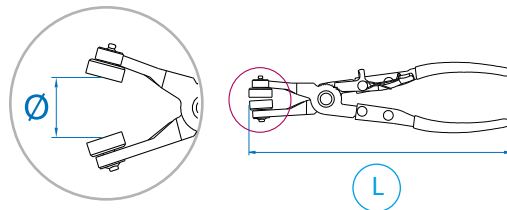

9AA31 \$100.70
Flexible Hose Clamp

- Use to remove and install spring clamp
- Flexible flat jaw with greater access in confined spaces
- Suitable for universal cars
- 1.16 LBS

Item	Ø	L1	L2
9AA31	12~53MM	25", 630MM	9", 225MM



9DC23 \$15.95
Automotive Voltage Tester

- Insulated alligator clip with 110cm (43-5/16") long cable
- 2 LEDs indicate Positive(+)/Negative (-) polarity
- For application of D.C. circuits only
- Two testing methods as illustration



Item	Length	Test Range
9DC23	138MM	3-48V

Engine Series



9AD11 \$53.25
Valve Stem Seal Pliers

- For removing valve stem seals in multi-valves engine
- Jaw longitudinal toothed - avoids slipping down
- For deeply leveled valve stem seals
- Length 275MM, 10-7/8", 0.97 LBS

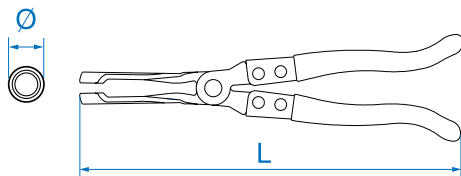

9AH11 \$264.50
10Pc. Valve Spring Compression Set

- Complete Service tool kit for OHV & OHC petrol or diesel engines on Audi, Nissan, Toyota, Chrysler, Honda, Mazda, Mitsubishi, Saturn, Lexus, Hyundai, Infiniti, Porsche, Volvo, VW
- Length 515MM, 9.33 LBS

9AR11 \$106.25
21Pc. Oil Drain Plug Key Set

- Suitable for sump plugs on engine, gearbox and back axle
- Contents:
 - Hex key socket: 8, 9, 10, 12, 13, 14, 17 mm
 - Square socket: 5/16", 3/8", 7, 8, 10, 11, 12, 13, 14 mm
 - Torx socket: T45
 - Triangular socket: 10mm
 - Spline (TAMPER) socket: M16
 - Square drive socket: 10mm
 - 3/8" drive sliding T-handle
- 3.96 LBS



Engine Series

9AK11 \$32.65

Universal Clutch Aligner Set

- Designed to make alignment and assembly of clutch
- Specially designed for those vehicles equipped with late-model front wheel drives-without pilot bearing in flywheel
- 1.32 LBS

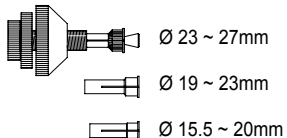

9AL12 \$65.90

Pulley Removing Wrench

- To lock the pulley during removing or assembling any type of pulley retaining bolt
- Length 365MM, 14-3/8", 1.29 LBS

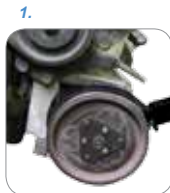
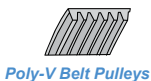

• Compressors

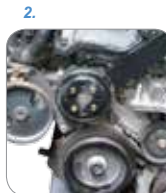

• Water pump pulley

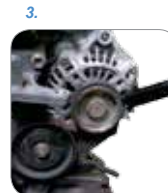

• Alternator pump pulley



• Oil filter removing & assembling

Engine Series

9AE2016 \$152.20

16Pc. Cup Type Oil Filter Wrench Kit

- Withstands up to 85 ft.lbs
- Coated with electro-black oxide finish for protection against rust
- 1PC. 1/2"(F)x3/8"(M) adaptor
- 1PC. 3 legged oil filter wrench(63-102mm)
- 8.80 LBS

9AE2-6606	66mm(2-19/32")-6 flutes-1 step Fiat(Punto, 1.2), Renault(Clio 1.2 Express, Kangoo. Rapid. Twingo), etc.
9AE2-7476	74 to 76mm(2-29/32" to 3")-15 flutes-2 step Fits Fram, AC, Saturn, Opel, VW, Audi, Mercedes, etc.
9AE2-7608	76mm(3")-8 flutes-1 step Fiat(z.B. Marea), Lancia(z.B. Delta), etc.
9AE2-7612	76mm(3")-12 flutes-1step Fiat(z.B. Ducato, Scudo, Ulysee),Renault, (Megane, Laguna, Espace III.), etc.
9AE2-7614	76mm(3")-14 flutes-1step Fits Champion, Champ Lee, Purolator, Mopar, VW, Porsche,Mercedes, BMW, Audi, Toyota, Opel, etc.
9AE2-8616	86mm(3-3/8")-16 flutes-1step Volvo(S40, S60, S70, S80) etc.
9AE2-8618	86mm(3-3/8")-18 flutes-1step VW. Golf.(MKIII. Tdi, Passat Tdi), Audi A6 Tdi, Renault(Clio, Rapid 1.9D, Laguna.Safrane. Espace 2.1D). Citroen, Peugeot, Renault, etc.
9AE2-9210	92mm(3-40/64")-10 flutes-1step Fiat, Cinquecento, Coupe, Croma, Fiat, Panda. Regata, Ritmo Fiat, Seicento. Tempra, Tipo, Lancia(Beta. Dedra. Kappa. Monte. Carlo. Prisma. Thema. Trevi), etc.
9AE2-9315	93mm(3-21/32")-15 flutes-1step Fits Casite, Champ, Champion, GM, Fram, Hastings,Purolator, Wix, Nissan, Volvo, Mazda, Audi, VW, Porsche, Renault, etc.
9AE2-9345	93mm(3-21/32")-45 flutes-1step VW-Audi.(TDi 2.4, 2.6, 2.8L), etc.
9AE2-9618	96mm(3-3/4")-18 flutes-1step Audi(A4 Tdi, VW Passat,97 Tdi), Renault (Laguna 2.2d. Safrane2.2D. Espace 2.2D. R19 2.2D. Rapid, Megane,1.9/2.1D. Tdi) etc..
9AE2-10615	106mm(4-11/64")-15 flutes-1step Fiat(Ducato 2.5D. Td), etc.
9AE2-10815	108mm(4-8/32")-15 flutes-1step Volvo(C70. S70. V70. Tdi. TD)(850 Tdi. TD) etc.
9AE2-10818	108mm(4-8/32")-18 flutes-1step Renault(Espace, Laguna, Master, Safrane, Traffic 2.4, 2.5, 2.8D. TD), etc.
9AE423	3 legged oil Filter Tool 63-102mm(2-1/2" to 4")
9AE221	1/2" drive adaptor 1/2" F x 3/8" M



Undercar Series

9BA11 \$191.90 10Pc. Bearing Race and Seal Driver Set

- Quickly and easily to insert bearing race
- Collars fit most standard wheel bearing size
- Helps reduce damage to both race and axle housing
- 9 collar sizes:

(1)1.555"/39.5mm	(2)1.752"/44.5mm
(3)1.968"/50mm	(4)2.322"/59mm
(5)2.480"/63mm	(6)2.559"/65mm
(7)2.834"/72mm	(8)2.992"/76mm
(9)3.189"/81mm	
- 3.98 LBS



9BA21 \$215.40 12Pc. 2 Sets Bearing Separator Assembly

- 2 Sets Bearing Separator & Bolts
- Capacity 30mm ~ 50mm
- Bolt 3/8" x L 120mm x 24UNF (415Hardenen 42 ~ 45)
- Capacity 50mm ~ 75mm
- Bolt 1/2" x L 135mm x 20UNF (415Hardenen 42 ~ 45)
- 4PC. Main Rod
- Hex Bar 17mm 3/8" x L 127mm x 2
- Hex Bar 14mm 3/8" x L 102mm x 2
- 4PC. Extension Rod
- Hex Bar 17mm 3/8" x L 127mm x 2
- Hex Bar 14mm 3/8" x L 102mm x 2
- 1PC. Beam (Carbon Steel)
- 1PC. Central Bolt - Hex 18mm x 9/16" x L 175mm x 10UNC
- 11.60 LBS



9BA22 \$246.85 8Pc. Pressure Screw Bearing Separator Puller

- Set Bearing Separator & Bolts
- Capacity 75mm ~ 105mm
- Bolt 5/8" x 18UNF x L 165mm (415Hardenen 42 ~ 45)
- 2PC. Main Rod - Hex Bar 19mm x M12 x 1/2" x L 255mm
- 2PC. Extension Rod - Hex Bar 19mm x M12 x L 255mm
- 1PC. Beam (Carbon Steel)
- 1PC. Central Bolt - Hex 21mm x M18 x L292 mm
- 1PC. Nut (Carbon Steel)
- 20.11 LBS

Undercar Series

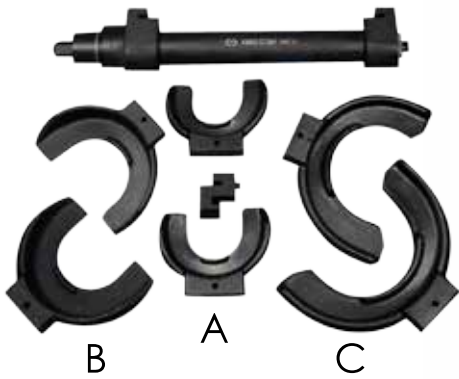
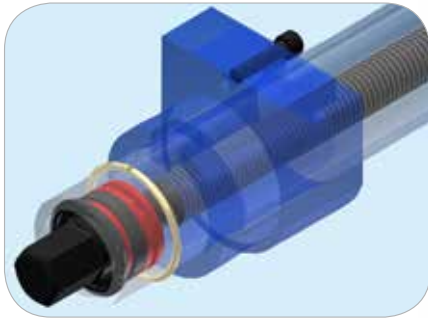

9BF31 **\$1050.35**

8Pc. Pressure Screw Bearing Separator Puller

- Developed for "Macpherson" suspensions, using a range of 3 sets interchangeable monobloc forks
- Spring specification / use:
 A: Ø80~115mm
 B: Ø110~150mm
 C: Ø140~195mm
- Suitable for : Bmw, Ford, Vw, Audi, Porsche, Saab, Opel, Volvo, Nissan, Honda, Mitsubishi, Subaru, Toyota
- 30.94 LBS

Item	Capacity	L
9BF31	40~300MM	460MM

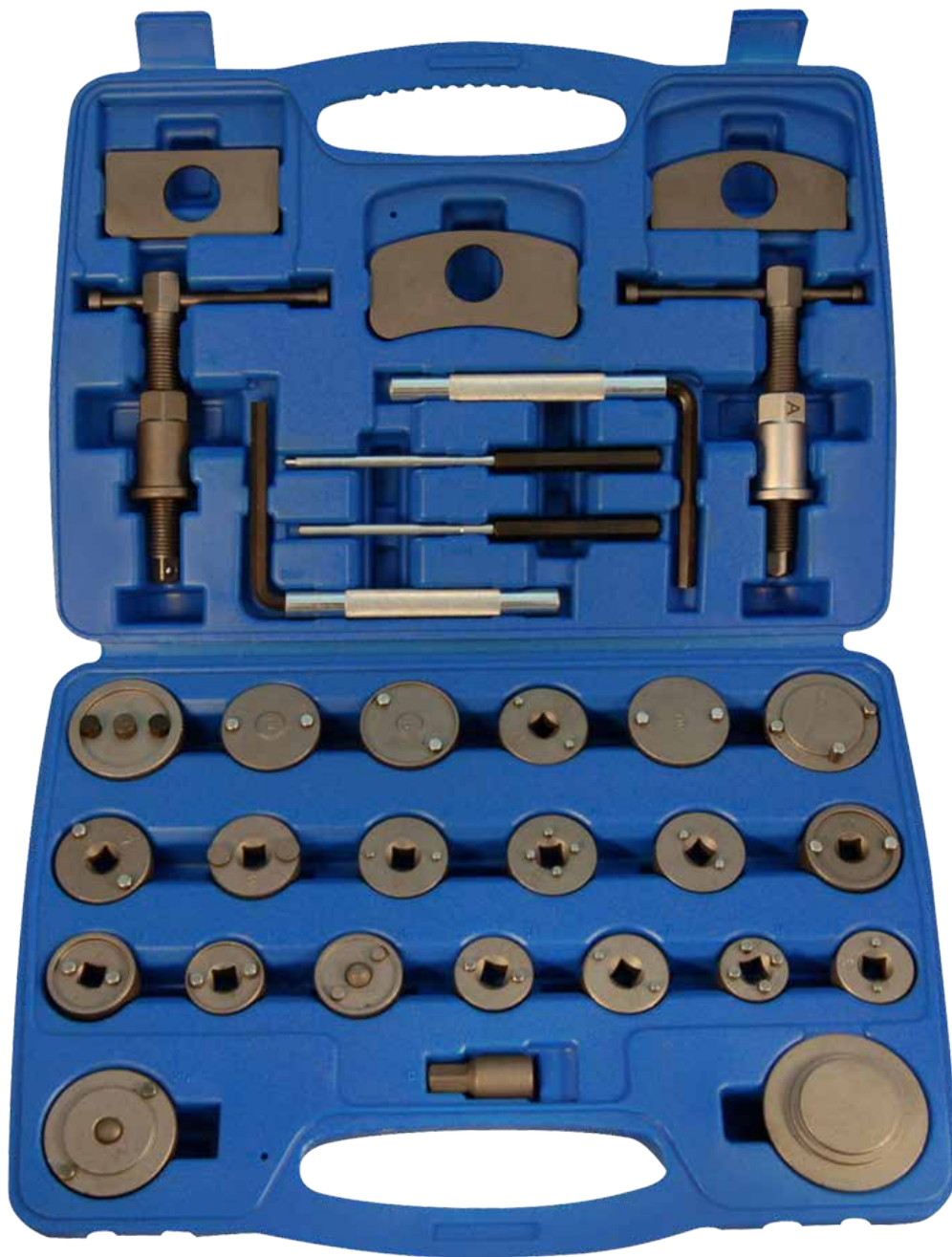

9BC23 \$385.15

31Pc. Universal Disc Brake Wind Back Tool Set

- For rotating pistons back into caliper to provide clearance for new pads
- Prevents damage to the piston and boot
- Suitable for Bmw, Ford, Vw, Audi, Porsche, Saab, Opel, Volvo, Jaguar, Citroen, Peugeot, Renault, Lauxhall, Lancia, Alfa romeo, Fiat, Nissan, Honda, Subaru, Toyota, Mitsubishi
- 10.50 LBS
- Contents:
 - 21pcs adapters for brake assemblage
 - 3pcs backing pads
 - 2pcs rotating caliper with 3/8"DR (right/left side threaded)
 - 2pcs hex key: 7, 8mm
 - 2pcs pin punch : Ø 5.5, 6mm
 - 1pc 3/8"DR x 12mm hex key socket

Undercar Series

9BG11 \$162.45

18Pc. Steering Wheel Puller Set

With hex on the puller for easier to fix the puller.

With deep thread to make the bolt powerful to remove or install the pulley.

- Two pulling flange plates in one set
- Small Plate Dia:
1" to 3-11/16" (25 to 95mm)
- Large Plate Dia:
1-1/8" to 5" (28 to 125mm)
- Bolt Size:
3 PC. 5/16" UNC x 3-1/2" long puller bolts
3 PC. 5/16" UNF x 3" long puller bolts
3 PC. 3/8" UNC x 3" long puller bolts
3 PC. 3/8" UNF x 3" long puller bolts
- 9.06 LBS



9BJ11 \$173.80

15Pc. Multi-Steering Knuckle Spreader Tool Set

- This kit is used to spread the steering knuckle to enable the removal and fitting of shock absorbers without the risk of damaging the aluminum or cast iron knuckle
- The tool is adjustable and suitable for steering knuckles with either a centralized slot or a non centralized slot
- Wide range of vehicle applications
- Designed for twin ball joints as fitted to Audi and Vw control arms
- Suitable for strut clamping bores on Audi, Vw, Bmw, Ford, Peugeot, Citroen, Renault, Seat, Skoda
- 2.39 LBS

